

# ZTG-1500

- Product Category: 1500W Single Output switching Power Supply
- Version No.: ZTAO3.0
- Release date: 1st May 2025

## product overview

ZTG-1500-XX series products is a 1500W chassis type industrial power supply, the output voltage includes 12V/24V/36V/48V/72V/110V/220V, etc., can be adapted to different load application requirements to meet the needs of most industrial applications, built-in multi-functions such as output voltage, output current, remote on/off control, auxiliary power supply and other functions to provide a variety of design flexibility, fan heat dissipation, as well as a full range of protections, to ensure that this series of products of high reliability and high stability.

## product naming

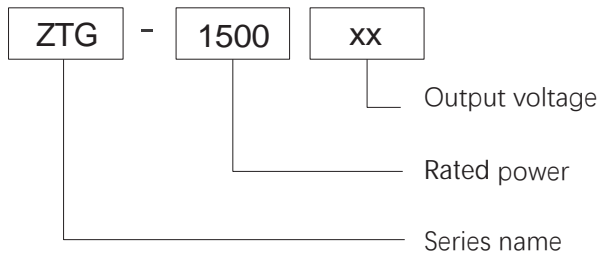

## product characteristics

- AC input range 180~264VAC
- Type of protection: short circuit/overload/over temperature
- remote on/off control
- fan cooling
- Power on LED indicator
- 100% full load burn-in test
- 3-year warranty



## areas of application

Industrial control, mechanical and electrical, electronic instruments, industrial automation, electronic equipment, UV curing equipment, semiconductor equipment, etc. (except information technology equipment)

## electrical specifications

Model		ZTG-1500-12	ZTG-1500-24	ZTG-1500-36	ZTG-1500-48	ZTG-1500-72	ZTG-1500-110	ZTG-1500-220	
Output	DC output voltage	12V	24V	36V	48V	72V	110V	220V	
	Rated current	125A	62.5A	41.7A	31.3A	20.9A	13.7A	6.9A	
	Current range	0~125A	0~62.5A	0~41.7A	0~31.3A	0~20.9A	0~13.7A	0~6.9A	
	Rated power	1500W	1500W	1501.2W	1502.4W	1504.8W	1507W	1520W	
	Ripple & Noise (Max)	200mVp-p	200mVp-p	260mVp-p	350mVp-p	500mVp-p	850mVp-p	1000mVp-p	
	Output Voltage Adjustment	0~13.2V	0~26.4V	0~39.6V	0~52.8V	0~79.2V	0~121V	0~242V	
	voltage accuracy	±1%	±1%	±1%	±1%	±1%	±1%	±1%	
	Linear adjustment rate	±1%	±1%	±1%	±1%	±1%	±1%	±1%	
	Load Adjustment Ratio	±1%	±1%	±1%	±1%	±1%	±1%	±1%	
	start-up & rise time	1800ms,120ms/230VAC (at full load)							
Input	Input Voltage	180~264VAC		245~370VDC					
	Input frequency	45~65HZ							
	Efficiency	85%	86%	87%	89%	90%	90%	91%	
	Input current	13A/230VAC							
	Leakage current	< 3.0mA/240VAC							
Protection	short-circuit protected	Protection mode: constant current limitation, restart recovery after removal of abnormal conditions							
	Over temperature	Output voltage is switched off and restored after temperature drop or reboot							
Function	constant current optimum range	6~12V	12~24V	18~36V	24~48V	36~72V	55~110V	110~220V	
	External potentiometer	External potentiometer control (voltage, current)							
	analogue signal control	0~5V/0~10V,0~5A/0~10A control (voltage, current)							
	Auxiliary power supply	12V 0.5A							
	Remote on/off control	Default power on, high level power off (3~12V)							
	Fan On/Off Control (Typ.)	The fan's spinning straight up							
Environment	Operating temperature	-20°C ~+60°C							
	Operating humidity	20~90%RH No condensation							
	Storage temperature/humidity	-40~+80°C 10~95%RH, no condensation							
Security	Vibration-resistant pressure resistance	10~500HZ, 5G 10 min/cycle, X, Y, Z 60 min each							
	Insulation impedance	Input to Output :1.5KVAC; Input to Ground :1.5KVAC; Output to Ground :500VAC							
	Product dimensions	Input to Output, Input to Ground, Output to Ground :100 Ohms/500VDC/25°C /70%RH 275*155*70mm (L*W*H)							
Others	Packaging	1.88kg/pcs							
	Remarks	<ol style="list-style-type: none"> <li>All parameters are measured at 230VAC input, rated load and 25°C when not otherwise specified.</li> <li>Ripple and noise voltages were measured on a 20MHz bandwidth oscilloscope with 0.1μ and 47μ capacitors at the end of a 12-inch twisted pair cable, measured at 20MHz bandwidth.</li> <li>Accuracy: Includes setting error, linear adjustment ratio and load adjustment ratio.</li> <li>Linear Adjustment Ratio Measurement Method: Test from low voltage to high voltage at rated load</li> <li>Load Adjustment Ratio Measurement Method: From 0% to 100% of rated load</li> <li>Start-up time is measured at cold start, fast and frequent switching on and off may increase the start-up time.</li> <li>When operating at altitudes higher than 2000 metres (6500ft): the operating environment needs to be reduced by 5°C / 1000 metres</li> </ol>							

Outline and Mounting Dimensions (mm)

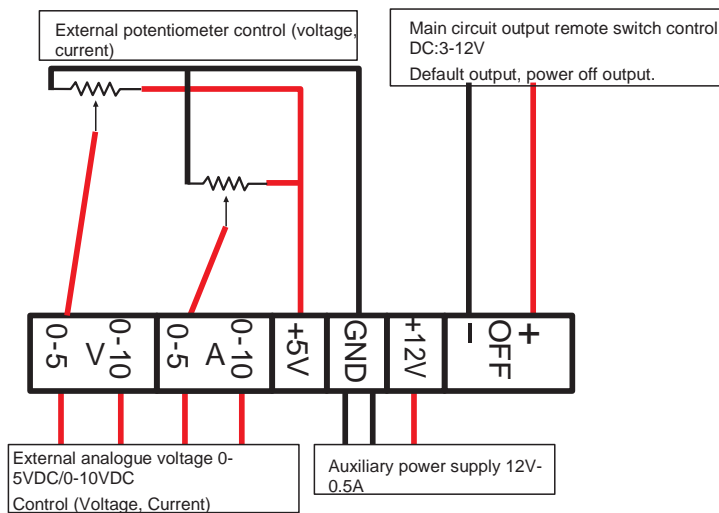
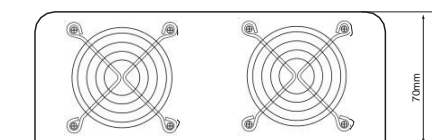
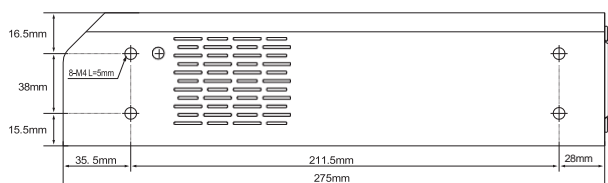
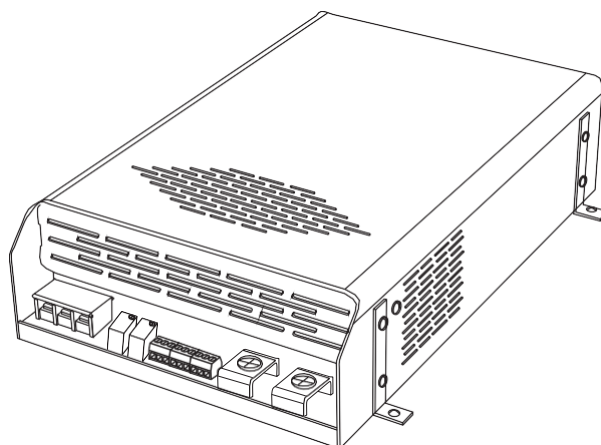
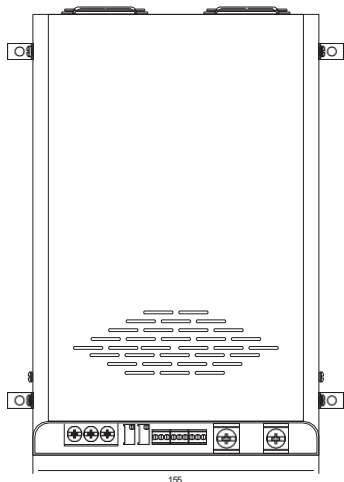

Pinout	Function	
L	AC LINE	Screw:M4*9.5 Torque:22Kgf.cn( 2.2N.m)
N	AC NETURAL	
⊕	EARTH	
-Vo	DC output -	Screw:M6*14 Torque:30Kgf.cn(3.0N.m)
+Vo	DC output +	

8-M4 Customer system

mounting holes

mounting screws: M4

Installation torque: 8Kgf.cn

(0.8N.m) screws into the housing

is not more than 3mm

Remarks:

Unit: mm [inch]; unlabelled tolerances are  $\pm 0.5$  [ $\pm 0.020$ ].

### Characteristic Curve

Input Voltage VS Output Load

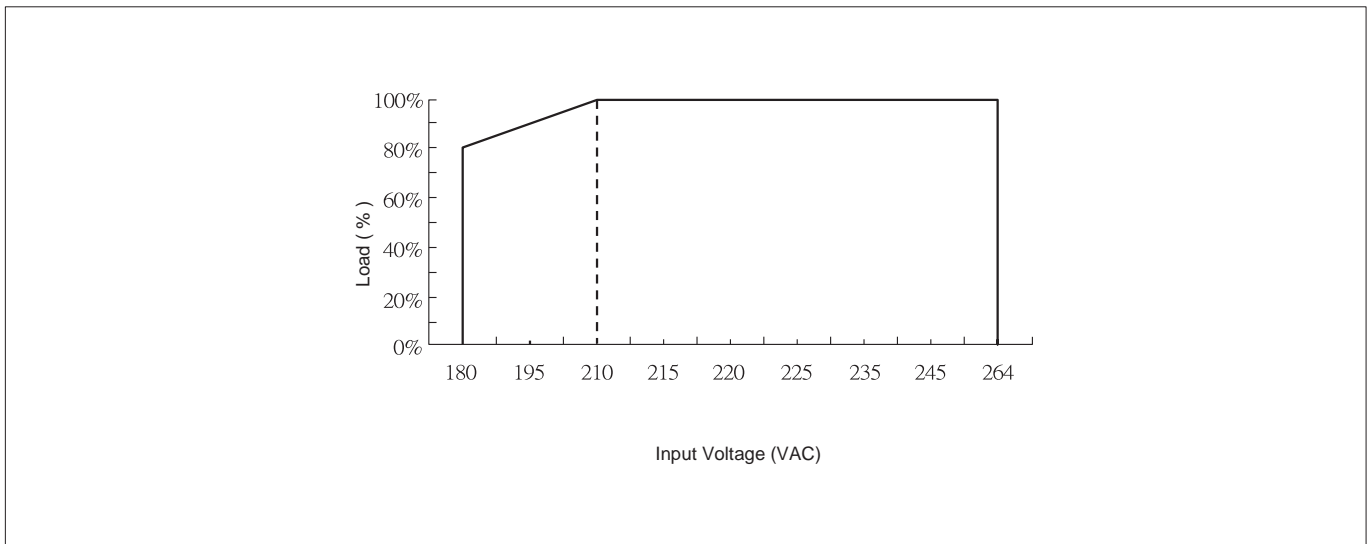

Ambient Temperature VS Output Load

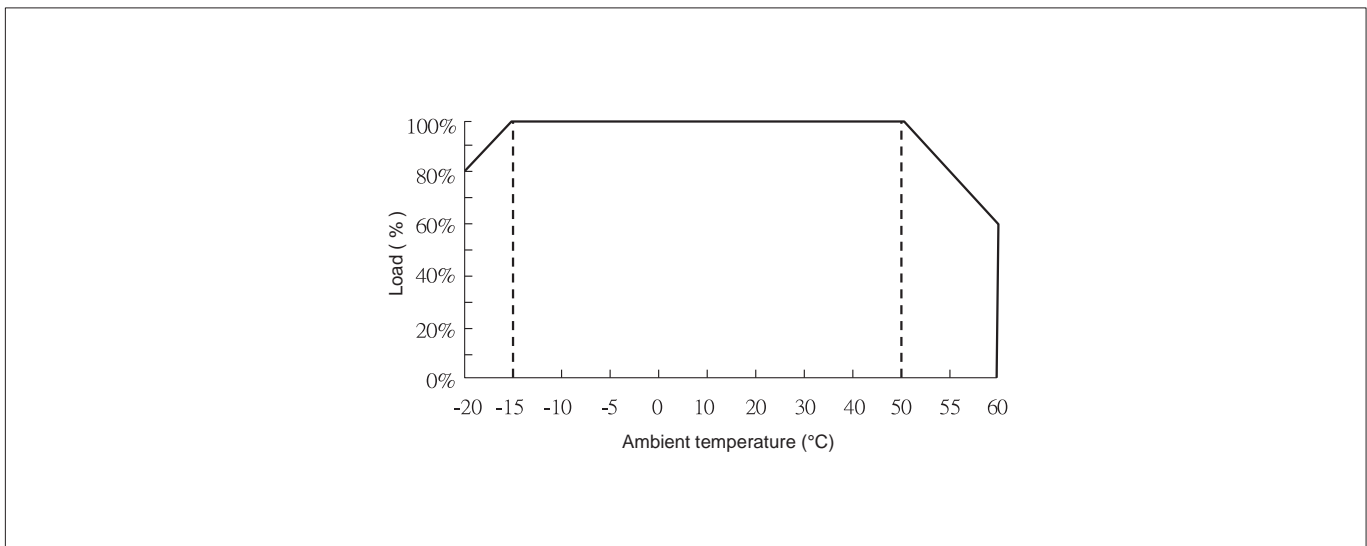

Remarks:

- 1.If you need to know more detailed test data, please contact our technical support to get the application notes of the corresponding products.
- 2.This product is suitable for use in a natural air convection environment, if used in a closed environment, please contact our technical support staff.